

Article number: 03703012

Description: Fluro rod end BRTF 12 L
threaded left with roller bearing

Measures

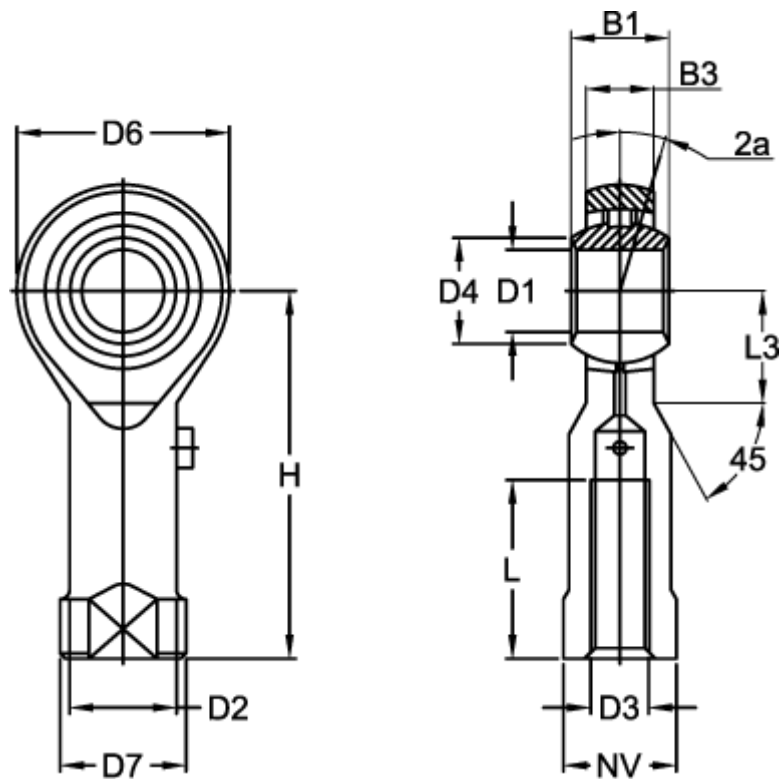

Angel 2a = 7.5	D7 = 22	Weight (kg) = 0.109
B1 = 16	Dynamic load C (N) = 10250	
B3 = 12.00	H = 50	
D1 = 12	L = 22	
D2 = 17.5	L3 = 16	
D3 = M12x1,75	Max rpm = 1125	
D4 = 14.5	NV = 19	
D6 = 32	Static load (N) = 6600	